

**CODE**  
SG 502

**SQUARE SHELF**



| AR     | SG 502           |                  |
|--------|------------------|------------------|
| SIZE   | FinishBlack Code | FinishBlack Rate |
| 12"x5" | SG502-A          | 1004/-           |
| 16"x5" | SG502-B          | 1302/-           |

**CODE**  
SG 504

**ROUND SHELF**



| AR     | SG 504           |                  |
|--------|------------------|------------------|
| SIZE   | FinishBlack Code | FinishBlack Rate |
| 12"x5" | SG504-A          | 818/-            |
| 16"x5" | SG504-B          | 1004/-           |

**CODE**  
303 R/G

AR



|        |        |
|--------|--------|
| Finish | 9"x10" |
| RG     | 1060   |

**CODE**  
SG 303

**SET UP BOX STAND**

AR

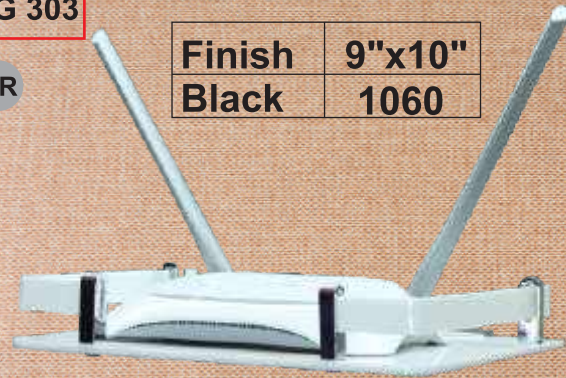

|        |        |
|--------|--------|
| Finish | 9"x10" |
| Black  | 1060   |

**CODE**  
SG 308

**DELUXE BRUSH STAND**

AR



|        |     |
|--------|-----|
| Finish |     |
| Black  | 688 |

**DOUBLE SOAP WITH TUMBLER (ROUND) 4 IN 1**

**CODE**  
SG 509

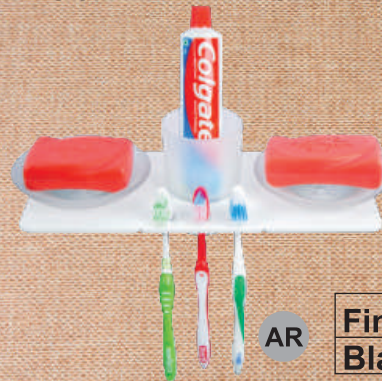

|        |      |
|--------|------|
| Finish |      |
| Black  | 1154 |

**SQUARE SOAP WITH TUMBLER**

AR

**CODE**  
SG 507



|        |     |
|--------|-----|
| Finish |     |
| Black  | 930 |

**SQUARE TUMBLER WITH BRUSH**

AR

**CODE**  
SG 707



|        |     |
|--------|-----|
| Finish |     |
| Black  | 762 |



**BATHROOM ASSESSORIES**

**SQUARE DOUBLE SOAP DISH**

**CODE**  
SG 606



AR

|        |      |
|--------|------|
| Finish |      |
| Black  | 1898 |

**DOUBLE SOAP DISH (SQUARE)**

**CODE**  
SG 513



AR

|        |     |
|--------|-----|
| Finish |     |
|        | 856 |

**SOAP DISK SINGLE (ROUND)**

**CODE**  
SG 706



AR

|        |     |
|--------|-----|
| Finish |     |
|        | 652 |

**DOUBLE SOAP DISH (ROUND)**

**CODE**  
SG 514



AR

|        |     |
|--------|-----|
| Finish |     |
| Black  | 744 |

**SQUARE SOAP WITH TUMBLER**

**CODE**  
SG 507



AR

|        |     |
|--------|-----|
| Finish |     |
| Black  | 930 |

**DOUBLE SOAP WITH TUMBLER (ROUND)**  
4 IN 1

**CODE**  
SG 509

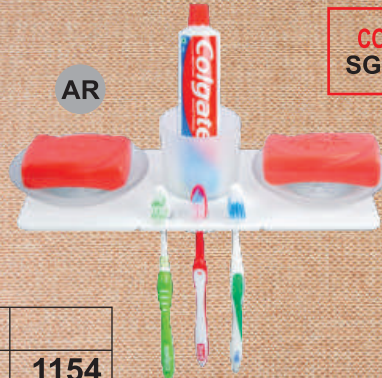

AR

|        |      |
|--------|------|
| Finish |      |
| Black  | 1154 |

**CODE**  
610 B



AR

|        |  |
|--------|--|
| Finish |  |
| Black  |  |

**CODE**  
505

Single Soap Dish



484/-



**ROUND SOAP WITH TUMBLER  
3 IN 1**

**CODE**  
SG 508



AR

|               |     |
|---------------|-----|
| <b>Finish</b> |     |
| <b>Black</b>  | 818 |

**DOUBLE SOAP WITH TUMBLER (SQUARE)  
4 IN 1**

**CODE**  
SG 510



AR

|               |      |
|---------------|------|
| <b>Finish</b> |      |
| <b>Black</b>  | 1264 |

**SOAP DISH & TUMBLER ROUND**

**CODE**  
SG 710



AR

|               |      |
|---------------|------|
| <b>Finish</b> |      |
| <b>Black</b>  | 1600 |

**SQUARE SOAP DISH**

**CODE**  
SG 604



AR

|               |      |
|---------------|------|
| <b>Finish</b> |      |
| <b>Black</b>  | 1340 |

**SOAP DISH & DISPENSER**

**CODE**  
SG 714



AR

|               |      |
|---------------|------|
| <b>Finish</b> |      |
| <b>Black</b>  | 1414 |

**SOAP DISH & TUMBLER ROUND**

**CODE**  
SG 716



AR

|               |      |
|---------------|------|
| <b>Finish</b> |      |
| <b>Black</b>  | 1172 |



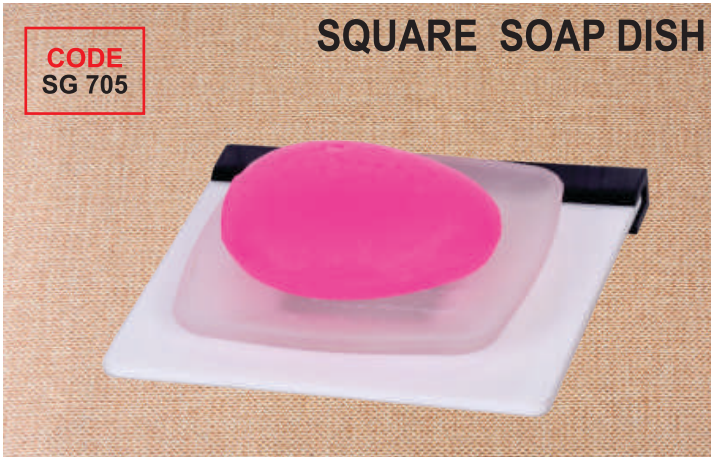

AR

|               |     |
|---------------|-----|
| <b>Finish</b> |     |
| <b>Black</b>  | 726 |



AR

|               |      |
|---------------|------|
| <b>Finish</b> |      |
| <b>Black</b>  | 1078 |



AR

|               |      |
|---------------|------|
| <b>Finish</b> |      |
| <b>Black</b>  | 1376 |



AR

|               |      |
|---------------|------|
| <b>Finish</b> |      |
| <b>Black</b>  | 2194 |



AR

|               |      |
|---------------|------|
| <b>Finish</b> |      |
| <b>Black</b>  | 1078 |



AR

|               |      |
|---------------|------|
| <b>Finish</b> |      |
| <b>Black</b>  | 2194 |



**MULTIPURPOSE CORNER (3 PC)  
Shakti (Small) Bahubali (Big)**

**CODE: PVC-6000**

**UNBREAKABLE SET OF 3 PCS**

| PVC-6000 |                   |                   |      |                   |                   |
|----------|-------------------|-------------------|------|-------------------|-------------------|
| SIZE     | Shakti Small Code | Set of 3 Pcs Rate | SIZE | Bahubali Big Code | Set of 3 Pcs Rate |
| 7"       | PVC6000-A         | 984/-             | 9"   | PVC6000-D         | 1226/-            |
| 9"       | PVC6000-B         | 984/-             | 11"  | PVC6000-E         | 1226/-            |
| 11"      | PVC6000-C         | 984/-             | 13"  | PVC6000-F         | 1226/-            |



**MULTIPURPOSE SINGLE CORNER**

**CODE: PVC-6001**

**PP (MILKY WHITE) SET OF 3 PCS**

| PVC-6001 |           |                   |      |           |                   |
|----------|-----------|-------------------|------|-----------|-------------------|
| SIZE     | MINI Code | Set of 3 Pcs Rate | SIZE | BIG Code  | Set of 3 Pcs Rate |
| 7"       | PVC6001-A | 450/-             | 9"   | PVC6001-D | 660/-             |
| 9"       | PVC6001-B | 450/-             | 11"  | PVC6001-E | 660/-             |
| 11"      | PVC6001-C | 450/-             | 13"  | PVC6001-F | 660/-             |



**CODE: PVC-6002**

**MULTIPURPOSE SHELF 16"**

**PV**

|             |    |
|-------------|----|
| Unbreakable | PP |
| <b>640</b>  |    |



**BRUSH HOLDER WITH TUMBLER (2 IN 1)**

**CODE: PVC-6003**

**PV**

|             |    |
|-------------|----|
| Unbreakable | PP |
| <b>162</b>  |    |



**SOAP DISH WITH TUMBLER (3 IN 1)**

**CODE: PVC-6004**

**PV**

|             |    |
|-------------|----|
| Unbreakable | PP |
| <b>256</b>  |    |



**MULTIPURPOSE SHELF WITH TUMBLER (4 IN 1)**

**CODE: PVC-6005**

**PV**

|             |    |
|-------------|----|
| Unbreakable | PP |
| <b>310</b>  |    |



**CORNER SHELF WITH TUMBLER (5 IN 1)**

**CODE: PVC-6007**

**PV**

|             |    |
|-------------|----|
| Unbreakable | PP |
| <b>364</b>  |    |



**CODE: PVC-6008**

**DULEX TRAY**

**PV**

|             |    |
|-------------|----|
| Unbreakable | PP |
| <b>324</b>  |    |





PV Unbreakable PP  
148



PV Unbreakable PP  
290



PV Unbreakable PP  
148



PV Unbreakable PP  
108



PV Unbreakable PP  
174



PV Unbreakable PP  
108



PV Unbreakable PP  
444

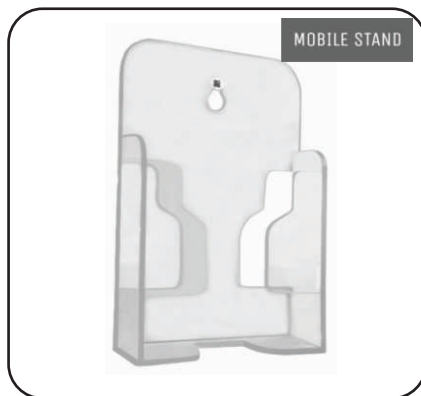

PV Unbreakable PP  
158



PV Unbreakable PP  
306



Sunita Agency e- Catalog

website: [www.sunitaagency.com](http://www.sunitaagency.com)

हमारे हार्डवेयर और बॉथरूम एसेसरीज प्रोडक्ट के फोटो, फिनिश, साइज और रेट लिस्ट देखने के लिए क्यू आर कोड और वेब साइट स्केन करे

- OT** Red - Other
- PV** White - PVC
- WD** Brown - Wood
- AR** Gray - Acrylic
- ME** Sky Blue - Metal
- IR** Black - Iron
- AL** Green - Aluminum
- BR** Yellow - Brass
- ST** Orange - Steel
- IM** Blue - Imported

नोट:

1. क्रेडिट लिमिट 30 दिन, 30 दिन में बिल क्लियर नहीं होने पर बिलिंग ऑटोमेटिक स्टॉप।
2. माल वापसी से सम्बन्धित सूचना बिल डेट से 7 दिवस के अन्दर केवल 9314067610 पर ही देनी है अन्य किसी मोबाईल नंबर एवम व्यक्ति को दी गई सूचना मान्य नहीं होगी।
3. बिल दिनांक से 7 दिन के बाद कोई माल वापस नहीं होगा। वापसी माल हमारी गाड़ी या हमारी कार से वापिस नहीं उठायेंगे। उसको आपको ट्रांसपोर्ट, आपकी गाड़ी, आपकी टैक्सी या आपके साधन से ही वापिस हमें भिजवायेंगे। वो भी बिल डेट से 7 दिन के अन्दर ही।
4. डिस्काउंट एवं रेट में हम कभी भी किसी भी समय बिना किसी पूर्व सूचना के परिवर्तन कर सकते हैं। हर बार डिस्काउंट एवं रेट में परिवर्तन की सूचना आपको नहीं दी जावेगी। हर बार माल मंगवाने से पहले आप आईटम वाईज डिस्काउंट एवं रेट के बारे में फोन पर अवश्य पूछें, अन्यथा हमारी कोई जिम्मेदारी नहीं होगी।
5. केश एवं चैक का भुगतान बिना रसीद के नहीं दें, बिना रसीद के दिया गया भुगतान मान्य नहीं होगा।
6. पेमेंट लेते समय आपके साइन बिल की कॉपी संभाल कर नहीं रखी जाएगी आप हर हफते हमसे स्टेंटमेंट मांग लेवे
7. बिल पर आपका जीएसटी नंबर चैक कर लेवे बाद में हमारी कोई जिम्मेदारी नहीं होगी।
8. पहली बार चेक बाउंस होने पर 500 + जीएसटी, दूसरी बार 2000 + जीएसटी, तीसरी बार 5000 + जीएसटी चार्ज लगेगा।

**HARDWARE GALLERY**  
135 BALAJI KRIPA INTERNATIONAL

